

FLAT PATCH

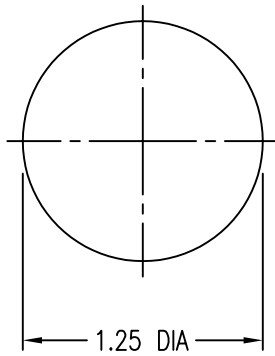

MEDIUM HAT PATCH

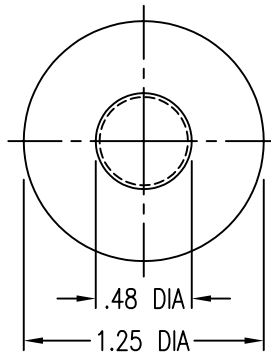

LARGE HAT PATCH

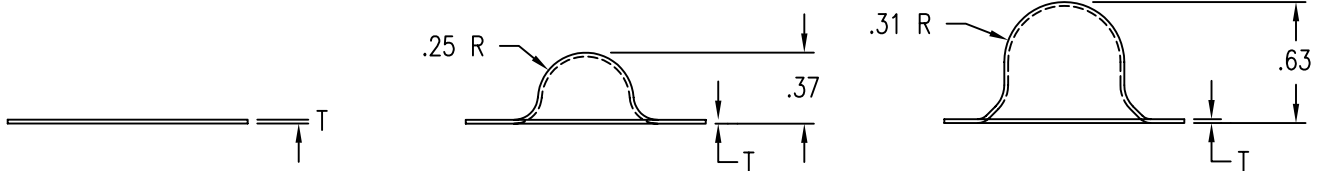
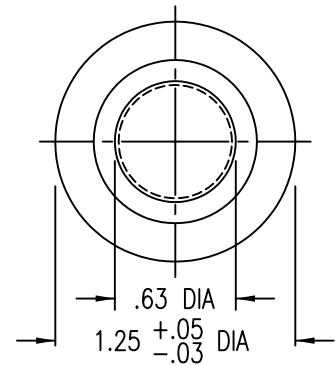

DISPOSABLE PRESSURE SENSITIVE ADHESIVE  
FIXTURE HOLDS PATCH WHILE ADHESIVE CURES.

LOCATION INDICATORS

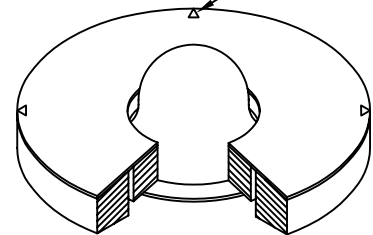
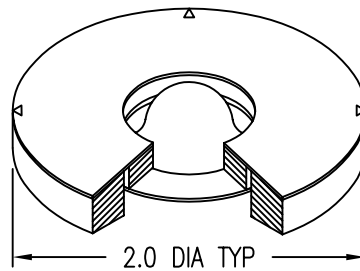
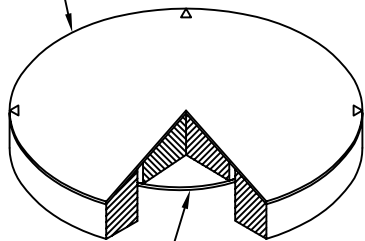

PATCH ATTACHED BY MEANS OF  
ADHESIVE APPLIED TO THIS SURFACE.

FLAT PATCHES

PART NUMBER	T	MATERIAL	FINISH
CP 125-000-005 A1A1	.005	ALUMINUM	ANODIZE
CP 125-000-015 G1	.015	FIBERGLASS	
CP 125-000-020 R1	.020	NYLON REINFORCED RUBBER	
CP 125-000-005 CR1	.005	STAINLESS STEEL 300 SERIES	
CP 125-000-005 T1	.005	TITANIUM	
CP 125-000-015 C1	.015	GRAPHITE/EPOXY	

EXAMPLE PART NUMBER  
CP125-000-005 A1 A1

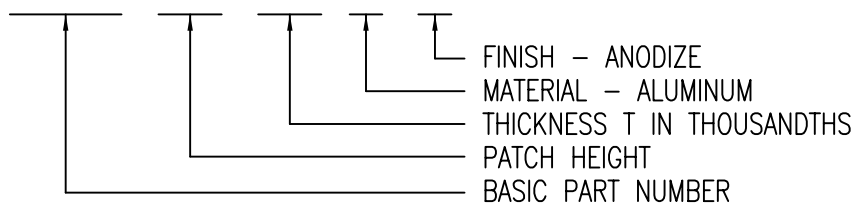

MEDIUM HAT PATCHES

PART NUMBER	T	MATERIAL	FINISH
CP 125-375-005 A2A1	.005	ALUMINUM	ANODIZE

LARGE HAT PATCHES

PART NUMBER	T	MATERIAL	FINISH
CP 125-625-005 A2A1	.005	ALUMINUM	ANODIZE

UNLESS OTHERWISE SPECIFIED, ALL DIMENSIONS ARE IN INCHES AND TOLERANCES ARE AS SHOWN BELOW. DIMENSIONAL TOLERANCES AND SYMBOLS PER ANSI Y14.5M-1982.

PROPRIETARY PARTS SHOWN IN THIS DRAWING ARE THE SUBJECT OF ISSUED UNITED STATES AND FOREIGN PATENTS AND PATENTS PENDING. UNAUTHORIZED REPRODUCTION AND/OR DISTRIBUTION OF THIS DRAWING IS SPECIFICALLY PROHIBITED.

**GLICK BOND**

CARSON CITY  
NEVADA 89706

		APPROVALS	DATE
ANGLES	±1°	DRAWN DAC	16JAN98
.XX	±.03	CHECKED DAC	16JAN98
.XXX	±.010	RELEASED CGH	19JAN98
.XXXX	±.001	REVISED DAC	16JAN98

TITLE			
PATCH, ADHESIVE BONDED			
SIZE	CAGE CODE	DWG. NO.	REV.
A	66530	CP125	2
SCALE	1/1	16JAN98	SHEET 1 OF 1